INSTRUCTIONS FOR SERIES AG3870 & AGD ULTRA HIGH PURITY, TIED SEAT, CORROSIVE GAS REGULATORS

THIS BOOKLET CONTAINS PROPRIETARY INFORMATION OF
ADVANCED SPECIALTY GAS EQUIPMENT CORP. AND IS PROVIDED
TO THE PURCHASER SOLELY FOR USE IN CONJUNCTION WITH
SERIES AG3870 AND AGD REGULATORS.



IMPORTANT

These instructions are for experienced operators who know the general principles and safety precautions to be observed in handling specialty gases and operating pressure regulation equipment. If you are not certain you fully understand the safety precautions for handling gases, we urge you to obtain and read the Material Safety Data Sheet (MSDS) for each gas being used.

Do not permit untrained persons to install, operate, or maintain this regulator. Do not attempt to install or operate this regulator until you have read and fully understand these instructions. If you do not fully understand these instructions, contact your Advanced Specialty Gas Equipment Distributor.

Be sure this information reaches the operator. Your supplier has extra copies.



This page has been left blank intentionally

SAFETY PRECAUTIONS

Protect yourself and others. Read and understand the following instructions before attempting to use these regulators. Failure to understand and follow these instructions could result in serious personal injury and/or damage to equipment.

- Know and understand the physical and chemical properties of the gas being used.
- Observe general precautions for the use of gases.
- Observe safety precautions for the gas being used.
- Read and follow precautions on cylinder labels.
- Never use these regulators with gases not compatible with the materials of construction. The use of gases not compatible with the materials of construction may cause damage to equipment or injury to personnel.
- If flammable gases are used with these regulators, do not locate the regulators near open flames or any other source of ignition.
- If toxic or flammable gases are used with these regulators, emergency equipment applicable to the gases in use should be available in the operating area.
- Many gases can cause asphyxiation by displacing oxygen in the atmosphere. Make certain the area where regulators are operated is well ventilated. Provide a device to warn personnel of oxygen depletion in the work area.
- Do not release toxic or flammable gases in the vicinity of personnel. Use this equipment only in well ventilated areas. Vent gases to the outside atmosphere, and in an area away from personnel. Be sure that venting and disposal methods are in accordance with Federal, State and local requirements. Locate and construct vent lines to prevent condensation or gas accumulation. Be sure the vent outlet cannot be obstructed by rain, snow, ice, insects, birds, etc. Do not interconnect vent lines; if more than one vent is needed, use separate lines.
- Relief devices should be installed and properly vented in all gas handling systems to protect against regulator failure and over-pressurization.
- Never use oil or grease on these regulators. Oil and grease are easily ignited and may combine violently with some gases under pressure.
- Never connect a regulator to a supply source having a pressure greater than the maximum rated pressure of the regulator. Refer to the Product Specifications (page 11) for maximum inlet pressures.

MANUFACTURER STATEMENT

The information contained in this instruction booklet has been compiled by Advanced Specialty Gas Equipment Corp., (the Company), from what it believes are authoritative sources and is offered solely as a convenience to its customers. While the Company believes that this information is accurate and factual as of the date printed, the information including design specifications is subject to change without prior notice.

DESCRIPTION

The AG3870 and AGD Series regulators are designed for use with ultra high purity, corrosive gases, such as those used in semiconductor manufacturing. They feature a tied seat design to insure positive shutoff if particulate matter should lodge in the seat, a common problem with corrosive gases.

The AG3870 Series single stage regulators reduce cylinder pressure in one step. They are intended for applications where inlet pressure does not vary greatly such as with liquefied gases. Each regulator is supplied with a diaphragm seal outlet valve to maintain gas purity.

The AGD Series two-stage design provides constant outlet pressure regardless of changes in cylinder (inlet) pressure.

OPTIONAL EQUIPMENT

Purge Assemblies – (Series SG3890) provide a means to introduce the purge gas into the system after the service gas cylinder has been connected. They are also used to remove toxic, corrosive and/or flammable gases before opening the system to the atmosphere during cylinder changeout.

Panel Mounting Ring – A special panel mounting ring permits the regulator to be mounted on a panel, using a 1 $\frac{3}{8}$ in. diameter hole.

PM3803 Panel Mounting Ring for Series AG3870
and AGD regulators.

INSTALLATION

WARNING: Before attempting to install and operate these regulators, read and fully understand the safety precautions on page 3 in this booklet. Failure to follow the safety precautions may result in serious personal injury and/or damage to equipment.

1. Inspect the regulator and cylinder valve for physical damage and contamination. Do not connect the regulator if you detect oil, grease or damaged parts. If the regulator is contaminated or damaged contact your Advanced Specialty Gas Equipment Distributor to have the regulator properly cleaned or repaired (see "Repairs"). Contact your gas supplier if the cylinder valve is damaged or contaminated.

Note: Make sure that the components and materials used in this gas handling system are compatible with the gas and have the proper pressure rating.

2. Close the regulator by turning the pressure adjusting knob counterclockwise until it reaches the stop. Do not turn the adjustment knob past the stop. Damage to the regulator could result. Close outlet valve by turning hand knob clockwise.
3. Secure cylinder in place using a suitable restraining device recommended by your gas supplier (such as a Model SG6202 bench clamp, or Model SG6203 wall clamp).
4. If the process gas is nonhazardous, connect regulator directly to the cylinder valve. Securely tighten connection nut.

If the process gas is hazardous (flammable, toxic and/or corrosive) or sensitive to atmospheric contaminants, connect a purge assembly between the cylinder valve and regulator. See purge assembly instructions for installation procedure.

5. Ensure that the delivery line is at atmospheric pressure before connecting regulator. Connect the regulator outlet to the delivery line.

Note: The use of joint compounds, pastes or lubricants other than Teflon® tape should be avoided since they may contaminate the regulator and process gas.

LEAK TESTING AND PURGING

1. If it is nonhazardous, use the process gas to leak test and purge the regulator and gas delivery system.

If the process gas is hazardous (flammable, toxic and/or corrosive) or sensitive to atmospheric contaminants, use clean dry nitrogen as a purge gas to leak test and purge the regulator and gas delivery system. A purge assembly can be used to connect a regulated nitrogen source to the inlet of the regulator. See purge assembly instructions for operating instructions.

2. Isolate downstream side of gas delivery system by closing instrument or process isolation valve.
3. Stand to one side of the regulator and slowly introduce the purge gas to the regulator. If a purge assembly is used, open the purge valve to introduce nitrogen to the regulator. Check inlet gauge for pressure into the regulator.
4. Open the regulator by turning the pressure adjusting knob clockwise until the desired pressure is indicated on the outlet gauge. Slowly open outlet valve by turning knob counterclockwise until knob stops turning.
5. Leak check all connections with either a soap solution, such as Snoop® or a gas leak detector. If a leak is detected, vent system to atmospheric pressure and repair. Do not repair any leaks while system is under pressure.

Note: These regulators do not vent downstream system pressure when the pressure adjusting knob is turned counterclockwise to reduce delivery pressure. For applications where atmospheric constituents could contaminate your gas system, install a vent valve on the downstream system to vent pressure. Connect outlet of vent valve to a safe disposal area.

6. Purge entire system of air if the process gas is hazardous or sensitive to atmospheric contaminants.
7. Vent system to atmospheric pressure. Close system vent valve. Close regulator by turning pressure adjusting knob counterclockwise. Close outlet valve by turning hand knob clockwise.

OPERATION

WARNING: Never operate a regulator under any circumstances if it is leaking or otherwise malfunctioning. DO NOT repair any leaks while system is under pressure. Damage to equipment and/or injury to personnel may result.

1. Close the regulator by turning the pressure adjusting knob counterclockwise until it reaches the stop. Do not turn the adjustment knob past the stop. Damage to the regulator could result. Close outlet valve by turning handknob clockwise.
2. Ensure that any purge and system vent valves are closed.
3. Slowly open cylinder valve to admit process gas to regulator.
4. Turn regulator pressure adjusting knob clockwise until desired delivery pressure is indicated on delivery gauge.

Note: Do not exceed maximum working pressure of downstream system components.

5. Slowly open outlet valve and adjust the delivery pressure if necessary.

SHUTDOWN

1. If regulator is not to be removed from service, close cylinder or process supply valve. Always keep cylinder or supply valve closed whenever the system is not in use.
2. Close regulator by turning pressure adjusting knob counterclockwise until it reaches the stop. This will prevent a sudden pressure surge from damaging downstream components when gas flow is restarted.
3. Close outlet valve by turning hand knob clockwise.

REMOVAL FROM SERVICE

1. Close cylinder or process supply valve. Always keep cylinder or supply valve closed whenever system is not in use.

WARNING: Hazardous gases must be discharged into a safety vent. Be sure to use a venting procedure that is environmentally acceptable and complies with Federal, State and local requirements.

2. Vent the system until both pressure gauges read zero psig. If regulator was used with a hazardous gas. Purge the regulator and entire system with clean dry nitrogen gas. Continue purging until the hazardous gas level in the system is below the TLV for the gas.
3. After purging and/or venting is complete, close regulator by turning pressure adjusting knob counterclockwise until it reaches the stop.
4. Close outlet valve by turning hand knob clockwise.

CAUTION: Always remove regulator and reinstall cylinder cap before moving cylinder.

5. Remove regulator from cylinder or supply line.

PERFORMANCE CHARACTERISTICS

Normal Operating Characteristics

- As flow is increased through a regulator, delivery pressure will drop (droop).
- As the inlet pressure to the regulator changes, the delivery pressure will vary (supply pressure effect). This effect is minimal in a two-stage regulator and more pronounced in a single-stage regulator.
- The difference in delivery pressure between flow and no-flow conditions is displayed on a regulator flow curve.

Abnormal Operating Characteristics

- Insufficient sealing of the valve seat assembly caused by foreign materials or wear will allow pressure to continue building in the low pressure chamber. The pressure rise may cease, or it may continue as a leak. If the latter occurs, the regulator must not be used until repaired.

CARE AND MAINTENANCE

Periodic checking of your regulator is essential to continued safe and satisfactory operation. How often you inspect will depend on the usage and type of gas.

It is recommended that regulators in non-corrosive gas service be inspected on at least a monthly basis and those in corrosive service at least once a week. We recommend that most regulators be serviced annually; those used in corrosive service may need servicing every six months. Generally, the valve seat assembly and diaphragm assembly will be replaced, especially if the regulator is used in corrosive gas service. It is even possible that some regulators must be scrapped if badly corroded.

Regulator Checking Procedure

1. Inspect gauges. The gauge(s) should read zero when all pressure has been relieved from the system.
2. Turn the pressure adjusting knob counterclockwise until it reaches the stop. Close the regulator outlet valve. Slowly open the cylinder valve. The high pressure gauge should read the cylinder pressure.
3. Leave the regulator in the pressurized state for five or ten minutes. The delivery pressure gauge should not register any pressure increase. A pressure increase indicates internal valve assembly leakage. If a pressure increase is indicated, the regulator must be repaired to prevent damage to downstream equipment.
4. Next, turn the pressure adjusting knob clockwise and set a nominal delivery pressure. If you are unable to attain the normal delivery pressure setting, faulty operation is indicated. This condition may be attributed to blockage caused by a stuck valve seat within the regulator. If the set delivery pressure continues to rise above the set point, the regulator valve seat may be worn. This condition is called "creep"; and a regulator exhibiting this condition should be sent for repair.
5. Close the supply valve and isolate the regulator from the downstream system (this can be done by closing the outlet shutoff valve if the regulator is so equipped) and note the pressure on both the high and low pressure gauges. After five or ten minutes a drop in pressure on either gauge indicates a leak in the system. The leak may be at the CGA connection, any threaded port, through the diaphragm, pressure gauge, or through the regulator outlet valve. If the leak is at the valve connection, relieve all pressure from the regulator and then tighten. If the leak is elsewhere, the regulator must be repaired.

REPAIRS

If a regulator leaks or malfunctions, take it out of service immediately. Do not attempt to repair these regulators. Repairs should be made only by Advanced Specialty Gas Equipment Corp. who has the special tools, test equipment and trained personnel required to make a safe repair. Tampering with the regulator voids the warranty. Contact your Advanced Specialty Gas Equipment Distributor to arrange for repair.

Repairs to regulators done after the initial warranty period has expired are chargeable to the customer. Upon receipt at the factory, the regulator will be inspected and you will be contacted with a repair cost estimate. No item will be repaired until approval is received. There will be an evaluation charge assessed for equipment not repaired. All repairs should be arranged through your Advanced Specialty Gas Equipment Distributor.

Note: All equipment being returned must be purged of all hazardous materials using a clean, dry inert gas (e.g. Dry Nitrogen) prior to return.

SPECIFICATIONS

Maximum Inlet Pressure	See Table 1 & 2
Inlet Pressure Gauge	See Table 1 & 2
Delivery Pressure Range	See Table 1 & 2
Delivery Pressure Gauge	See Table 1 & 2
Filter	40 Micron
Gauge Size	2 in. Dial
Operating Temp. Range	-40°F to +140°F
Flow Coefficient Regulator	
AG3870 Series	$C_V = 0.06$
AGD Series	$C_V = 0.05$
Outlet Valve	$C_V = 0.17$
Flow Capacity	See Figures 1-2
Supply Pressure Effect	
AG3870 Series	1.5 psi per 100 psi
AGD Series	0.06 psi per 100 psi
Inlet Connections	CGA 320, 326, 330, 350, 580, 660 or 705 as ordered
Outlet Connection	¼ in. NPT female (on outlet valve)
Weight (approx.)	
AG3870 Series	3 lbs.
AGD Series	4 lbs.

MATERIALS OF CONSTRUCTION

Body and Outlet Valve	Type 316 Stainless Steel Bar Stock
Gauges	Type 316 Stainless Steel
Bonnet	300 Series Stainless Steel
Other Metal Parts Exposed to Gas	Type 316 Stainless Steel
Seats	PCTFE
Diaphragms	Type 316 Stainless Steel
Seals	Teflon®

Table 1, AG3870 Models**Inlet Pressure**

Part No.	Max.	Gauge (dual scale)	
		(psig)	(bar)
AG3870-(CGA)	800	0-1000	0-69
AG3872-(CGA)	800	0-1000	0-69
AG3873-(CGA)	800	0-1000	0-69
AG3874-(CGA)	3000	0-4000	0-275
AG3876-(CGA)	3000	0-4000	0-275
AG3877-(CGA)	3000	0-4000	0-275

Delivery Pressure

Part No.	Range	Gauge (dual scale)	
		(psig)	(bar)
AG3870-(CGA)	2-30	-30" Hg-0-60	-1-0-4
AG3872-(CGA)	4-75	-30" Hg-0-100	-1-0-7
AG3873-(CGA)	10-150	-30" Hg-0-200	-1-0-14
AG3874-(CGA)	2-30	-30" Hg-0-60	-1-0-4
AG3876-(CGA)	4-75	-30" Hg-0-100	-1-0-7
AG3877-(CGA)	10-150	-30" Hg-0-200	-1-0-14

Note: Insert applicable CGA connection number to complete part number. Example: AG3874-580.

Table 2, AGD Models**Inlet Pressure**

Part No.	Max.	Gauge (dual scale)	
		(psig)	(bar)
AGD-3-30-(CGA)	3000	0-4000	0-275
AGD-3-75-(CGA)	3000	0-4000	0-275
AGD-3-150-(CGA)	3000	0-4000	0-275
AGD-2-30-(CGA)	800	0-1000	0-69
AGD-2-75-(CGA)	800	0-1000	0-69
AGD-2-150-(CGA)	800	0-1000	0-69

Delivery Pressure

Part No.	Range	Gauge (dual scale)	
		(psig)	(bar)
AGD-3-30-(CGA)	2-30	-30" Hg-0-60	-1-0-4
AGD-3-75-(CGA)	4-75	-30" Hg-0-100	-1-0-7
AGD-3-150-(CGA)	10-150	-30" Hg-0-200	-1-0-14
AGD-2-30-(CGA)	2-30	-30" Hg-0-60	-1-0-4
AGD-2-75-(CGA)	4-75	-30" Hg-0-100	-1-0-7
AGD-2-150-(CGA)	10-150	-30" Hg-0-200	-1-0-14

Note: Insert applicable CGA connection number to complete part number. Example: AGD-3-30-580.

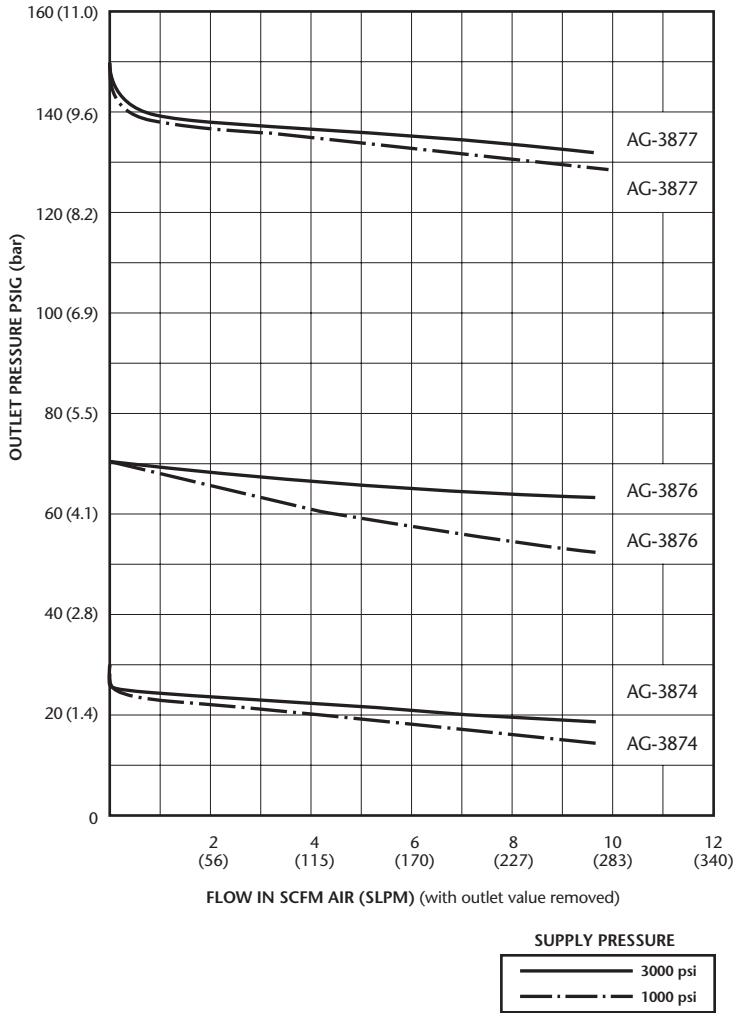

Figure 1 – Typical Performance
AG3870 Series

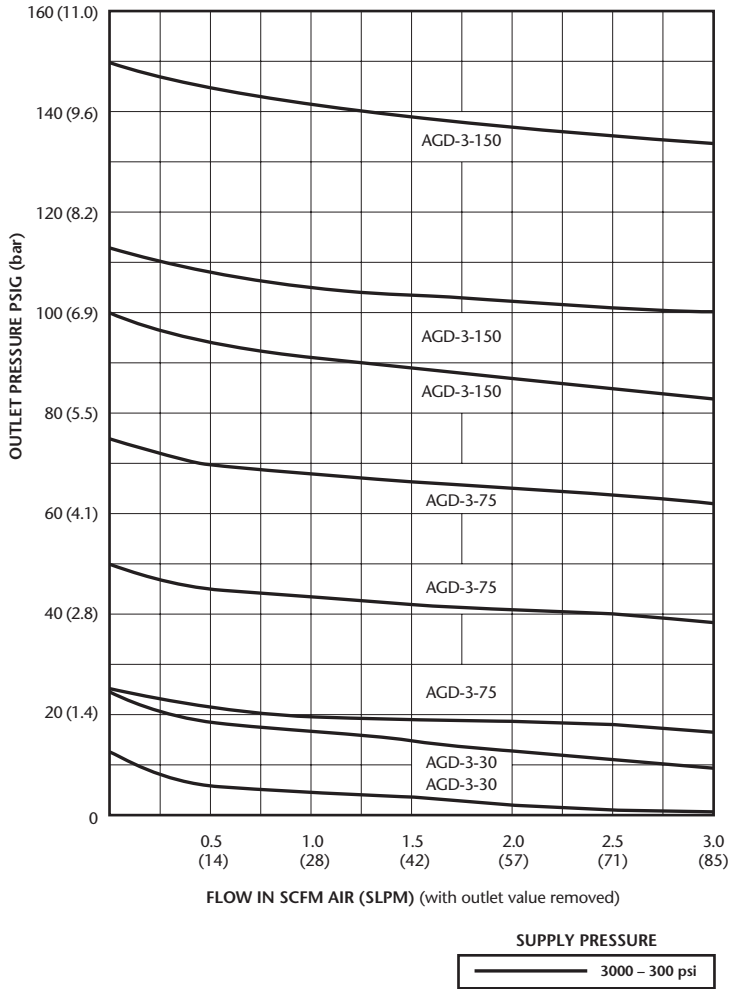

Figure 2 – Typical Performance
AGD Series

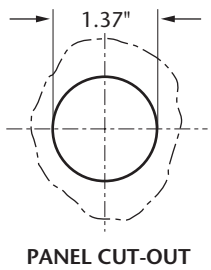
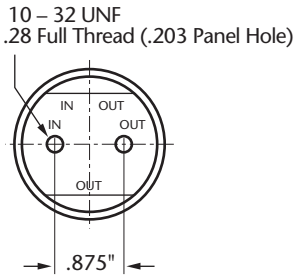
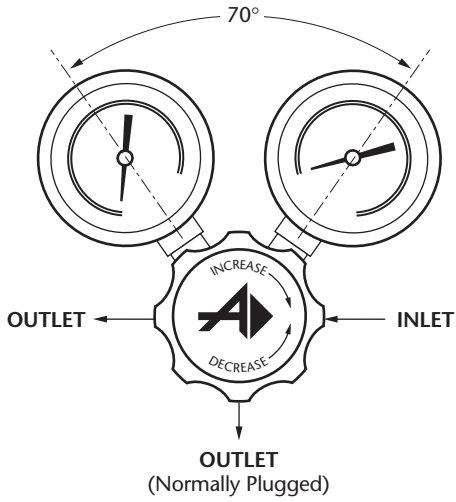
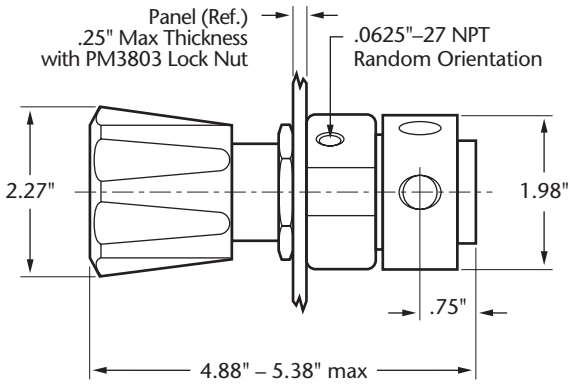
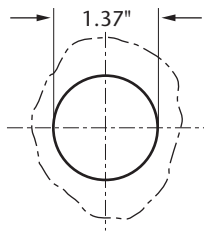
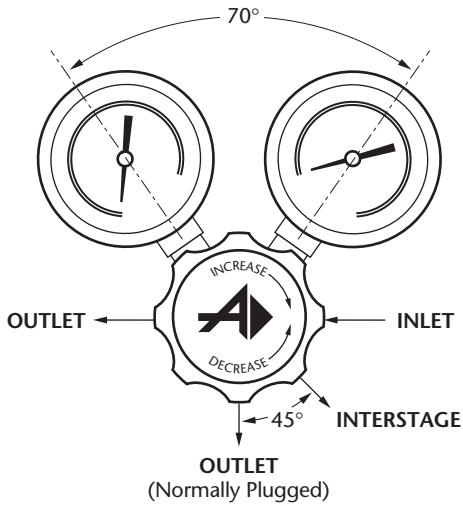
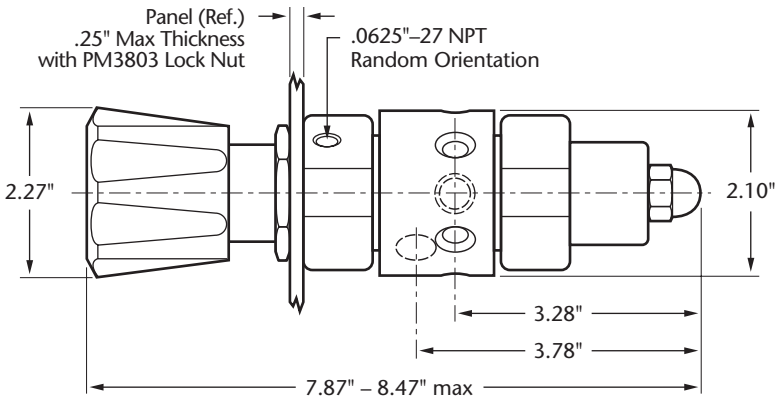

Figure 3 – Model AG3870 Series
 All Dimensions are Reference Only



PANEL CUT-OUT

Figure 4 – AGD Series
All Dimensions are Reference Only

WARRANTY

Advanced Specialty Gas Equipment Corp., (the Company), warrants to the initial purchaser of each regulator described herein, that such equipment will be free from defects in material and workmanship which result in breakdown or failure under normal use during a period of 12 months from date of shipment by the Company if used and maintained according to Advanced Specialty Gas Equipment written instructions. Purchaser is aware that this equipment is designed for specific applications and that using this equipment with the wrong or improperly purged gas or at the wrong pressure may damage or corrode the unit and cause personal injury. This warranty does not cover damage or malfunction due to contamination or corrosion. Purchaser must confirm that this equipment is compatible with the gas being passed through it. If there is any doubt about compatibility, consult your Advanced Specialty Gas Equipment Corp. distributor.

The Company's liability under this warranty shall be limited to the repair, or at its option, replacement or refund of the purchase price, of such equipment which proves to be defective, provided; however, that this warranty shall only apply if the purchaser (1) gives the Company written notice within ten (10) days after discovery of such defect, (2) immediately on discovery of the claimed defect, discontinues all use of such equipment, and (3) returns such equipment freight prepaid to plant of manufacture.

THERE ARE NO EXPRESS WARRANTIES OTHER THAN THOSE SPECIFIED HEREIN. NO WARRANTIES BY ADVANCED SPECIALTY GAS EQUIPMENT CORP. (OTHER THAN WARRANTY OF TITLE AS PROVIDED IN THE UNIFORM COMMERCIAL CODE) SHALL BE IMPLIED OR OTHERWISE CREATED UNDER ANY APPLICABLE LAW, INCLUDING BUT NOT LIMITED TO WARRANTY OF MERCHANTABILITY AND WARRANTY OF FITNESS FOR A PARTICULAR PURPOSE. No claim against the Company of any kind, whether as to equipment delivery or for nondelivery of equipment and whether or not based on contract, warranty, negligence, strict liability in tort or otherwise, shall be greater in amount than the purchase price of the equipment in respect of which such claim is made. Without limiting the generality of the foregoing, Advanced Specialty Gas Equipment Corp. shall not be liable for any special, indirect, or consequential damage, such as failure of parts resulting from corrosion.

If it is determined by Advanced Specialty Gas Equipment Corp. that the equipment is to be repaired or replaced under the terms of this warranty, the cost of returning said equipment to the initial purchaser will be paid by the Company. If, however, equipment returned to the Company in connection with a claim under this warranty is found by the Company not to be defective hereunder, then such equipment will be returned to the initial purchaser, shipping charges collect, and additionally, a service charge will be paid by the purchaser to the Company to cover the cost of handling and testing such equipment.

This page has been left blank intentionally



241 Lackland Drive, Middlesex, NJ 08846
Phone: 732-271-9300 Fax: 732-271-1630 www.asge-online.com